

Combi

Child Car Seat Malgott

Prim Long

User Guide

- For safety of the baby, please read this user guide carefully before use and use the product accordingly.
- Store this user guide in the pocket underneath the main body. (Refer to P.4)



Before Use

Before installing to the car

Installing to the car

Care and Maintenance

This product is tested and certified according to ECE R44/04.

- Universal: G0,G1,G2
- Applicable weight: up to 25kg



DANGER

Please install the child car seat in backward facing mode for baby weighing below 9kg. It is very dangerous to use forward facing mode under this condition.





Before use

Before use

Thank you for purchasing our child car seat. Before use, please read the user guide carefully and use the product accordingly.

The Child car seat is designed to reduce the injury to the child in case of traffic accident. But it is not guarantee that the seat can completely protect the child from injury. When using the child car seat, a child to use it must accompany with guardian.

The caution items mentioned in this user guide are for your reference in order to use this product safely. [danger],[warning] and [caution] indicate the potential consequences if the mentioned are not followed properly and are categorized according to the level of severity.

| Labels | Contents of the labels |
|--|---|
|  DANGER | Improper operation will directly result to death or severe injury. |
|  WARNING | Improper operation may cause death or severe injury. |
|  CAUTION | Improper operation may cause injury or damage to the product. |
| HINT  | It is the recommendations about usage of child car seat and useful hints. |

Content

| Before Use | | Installing to the car | |
|---|------|---------------------------------------|-------|
| Before use | 1 | Installing to the car | 16 |
| Name of components | 3-4 | Preparation | 16 |
| Using conditions | 5 | Backward facing installation | 17-19 |
| Type of vehicle seat belts and important notes for installation | 6 | Checklist after backward installation | 20 |
| Inapplicable vehicle seats | 7 | Forward facing installation | 20-21 |
| For safe use of the child car seat | 8-11 | Checklist after forward installation | 22 |

| Before installing to the car | | Maintenance / Others | |
|-------------------------------------|-------|-----------------------------|------------|
| Using the inner cushion | 12 | Detaching the seat cover | 22-23 |
| Length adjustment of the baby belt | 13 | Attaching the seat cover | 23-24 |
| Seating the child | 14-15 | Washing method | 24 |
| | | Storage | 25 |
| | | Product specification | 25 |
| | | Angle checker | Back cover |











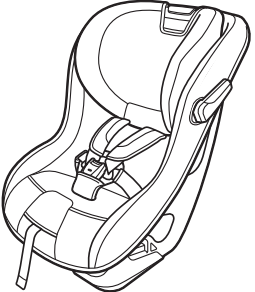

Before us

Name of components

Please check all components are available before use. The simplified illustration here is for easy understanding for customers and there may be a bit different from the actual product.

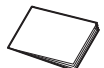
Before use

Package content

| <ul style="list-style-type: none"> • Main body  | <ul style="list-style-type: none"> • Inner cushion <table border="1"> <thead> <tr> <th>EG-model</th> <th>S-model</th> </tr> </thead> <tbody> <tr> <td> <ul style="list-style-type: none"> ● Inner cushion (head part)  </td> <td>  </td> </tr> <tr> <td> <ul style="list-style-type: none"> ● Inner cushion (seat part)  </td> <td>  </td> </tr> </tbody> </table> | | EG-model | S-model | <ul style="list-style-type: none"> ● Inner cushion (head part)  |  | <ul style="list-style-type: none"> ● Inner cushion (seat part)  |  |  <p>User guide</p> |
|---|--|---------|----------|---------|--|--|---|--|---|
| | EG-model | S-model | | | | | | | |
| <ul style="list-style-type: none"> ● Inner cushion (head part)  |  | | | | | | | | |
| <ul style="list-style-type: none"> ● Inner cushion (seat part)  |  | | | | | | | | |

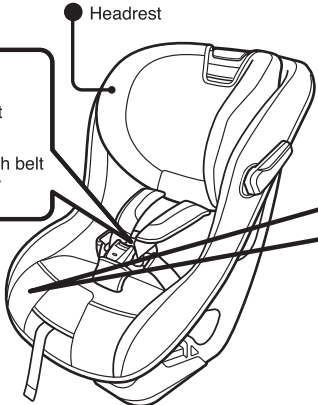

Front

- Buckle button
- Buckle
- Color indicator
- Crotch belt
- Insert metal
- Crotch belt cover

Under the seat cover

- Urethane
- Seat pad
- Baby belt adjustment button
- Adjustment belt

Headrest

Name of components (Please check all components are available before use.)

Front

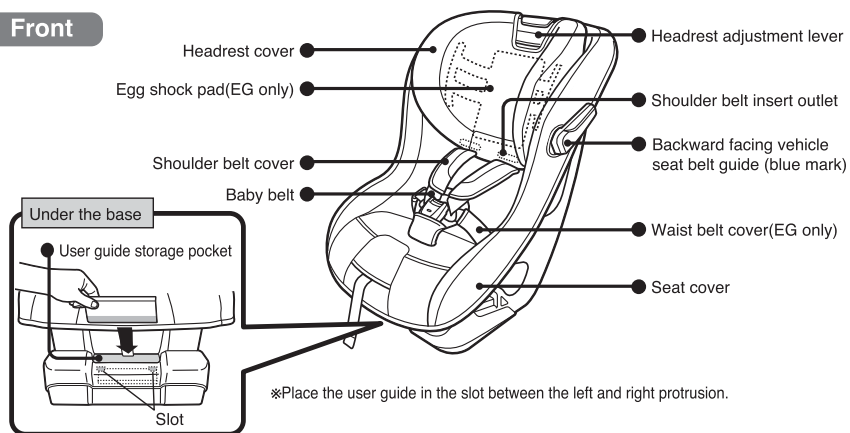

Back

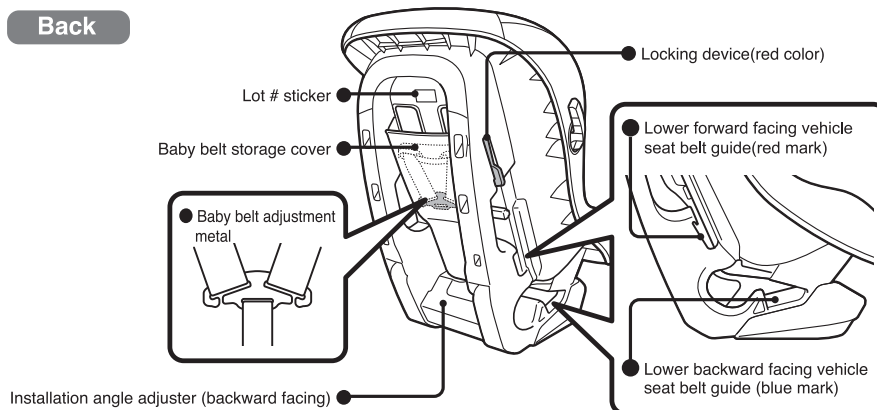

※Please refer to P.12 to know more about "Using inner cushion".



Before use

Using conditions

This part describes how to determine the installation direction, explains how to use inner cushion. Use properly according to the baby body weight. The child car seat can be used in 3 different ways according to the child's weight.

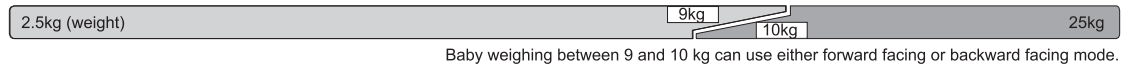
Before use



| Backward facing | | Forward facing | |
|--|---|---|--|
| <p>1 For baby weighs under 7kg</p> <ul style="list-style-type: none"> • Backward facing against driving direction. • Inner cushion(both head part and seat part) must be used. • Angle adjuster should be used.  | <p>2 For baby weighs from 7 ~ 10kg</p> <ul style="list-style-type: none"> • Backward facing against driving direction. • Inner cushion(seat part) must not be used. ※ Inner cushion(head part) can be used according to the child's body size. • Angle adjuster should be used.  | <p>3 Baby weighing 9kg - 25kg</p> <ul style="list-style-type: none"> • Forward facing against driving direction. • Inner cushion must not be used. • Remove the seat pad when the crotch belt cover becomes too tight. • Do not use the angle adjuster.  | |
| <p>CAUTION</p> <ul style="list-style-type: none"> • To avoid stress caused to child, refrain from continuous usage for a long time and make sure child should take rest once every hour. For child whose neck muscle has yet to develop, pay particular attention. | | | |
| <p>Using conditions</p> <ul style="list-style-type: none"> ● Height reference: ~60cm ● Age reference: newborn to 4 months old (when the baby neck muscle is developed). ● Newborns are referred to newly born infants weighing above 2.5kg and carried for above 37 weeks in pregnancy. | | <p>Using conditions</p> <ul style="list-style-type: none"> ● Height reference: 60 ~ 75cm ● Age reference: 4 months old (when the baby's neck muscle is developed) ~ 1 year old | |
| | | <p>Using conditions</p> <ul style="list-style-type: none"> ● Height reference: 75-120cm ● Age reference: 1 ~ 7 years old. | |

! DANGER

- Please note that the applicable height and age stated above are for reference only. Please refer to the weight conditions in order to choose the appropriate mode to use with.
- Do not use in forward facing position until baby weight is over 9kg.

Types of seat belt and important notes for installation

Installation method varies according to different types of seat belt. Some cars are unable to install our product.

Only suitable if the approved vehicles are fitted with lap / 3 point / static / with retractor safety-belts, approved to UN/ECE Regulation no.16 or other equivalent standards.



DANGER

- Make sure to install the child car seat onto vehicle seats with 3-point safety belts.
- Do not install it onto seats with 2-point safety belts or it may not function as designed.

Before use

| Types of Seat belt | Characteristics (distinction method) | Caution of backward facing mode | Caution of forward facing mode |
|--------------------|---|---|--|
| ELR | Extendable normally but locked in sudden retraction | Slowly pull out the seat belt and fix the child car seat properly. | Slowly pull out the seat belt and using locking device to fix the child car seat |
| AELR | After the seat belt is pulled out completely, it will lock the belt during winding back. Seat belt cannot be elongated anymore. (It will be unlocked after it is completely winded back.) | It is dangerous to completely pull out the seat belt. Please wind back the seat belt and unlock the car seat lock function for installing the car seat. | Using locking device to fix the belt for installation first. After finish the installation, then pull out all the seat belt and then release it. |
| NR | Seat belt without retracting device | Set the seat belt to an appropriate length to fit the child car seat. | Adjust the length of seat belt to fit the child car seat and using locking device to fix it. |
| NLR | Seat belt with retracting device but without a locking device. | | |
| ALR | The seat belt will be locked once it is stopped while being pulled out. | Not applicable for installation | |

2-point seat belt

As shown in the figure, this is the seat belt using the waist belt from each side as a 2-point support to the body.

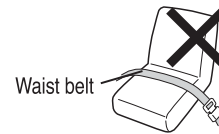

Waist belt

3-point seat belt

As shown in the figure, this is the seat belt using the waist belt from each side and shoulder belt as a 3-point support to the body.

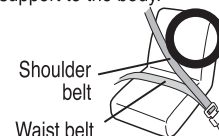

Shoulder belt

Waist belt

※ Should you have any enquiries about the types of seat belt, please contact the vehicle supplier.

Inapplicable vehicle seats

Inapplicable vehicle seats

Before use

Please do not install this product on the unsuitable vehicle seat even though it has not been mentioned below.

- Vehicle seat without seat belt.



- Vehicle seat with 2-point seat belt.



- Vehicle seats equipped with a passive seat belt.

Passive seat belt refers to seat belt that automatically buckles itself upon sitting.



- Vehicle seat with a mounted middle portion which cannot secure the child car seat.



- Vehicle seat with sitting depth of less than 40cm.

less than 40cm

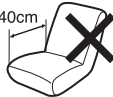

- Buckle seat with a hollow seat surface.



- Vehicle seat equipped with airbag.

Seat equipped with only side air bag is applicable.



- The installation length of seat belt less than 32cm.

The length between the extension point and the buckle of the seat belt.



less than 32cm

- Vehicle seat facing rear or sideways against the driving direction.

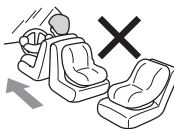

- Vehicle seat with extra large headrest.
- Due to the shape of headrest, the headrest adjustment of the child car seat cannot be operated.

* On vehicle seat of which the headrest is removable, the child car seat can be used if the car seat is installable after removing the vehicle seat headrest.



- Vehicle seat with seat belt extending from the center part.

Seat belt is extending from the middle of the vehicle seat where is located in the front of seat belt guide.



Seat belt guide

- Vehicle seat with extremely short seat belt.



For safe use of the child car seat

! DANGER

The following misuses may cause malfunction to the child car seat and lead to danger.

- Do not seat a child who does not satisfy the applicable conditions, or install on a seat which is inapplicable.



- Do not install the child car seat on a vehicle seat equipped with air bag. In case of collision, the exploded air bag will expose the child to major impact which is extremely dangerous. Vehicle seat equipped with side air bag is applicable.



- Do not allow child to stand on the child car seat. Please make sure the crotch belt are properly installed. The baby belt is well fastened to the buckle and color indicator is shown in green.



- Never use the child car seat which cannot be secured as stated in this user guide. Please install the child car seat to the other vehicle seats.



- Always fix the child car seat with the vehicle seat belt when installing onto the vehicle. Never use a rope, string or other than seat belt to fix it.



! In case of emergency

- Do not install the car seat wrongly. Please install correctly according to user guide or indication stickers on the product.



In case of emergency, such as accidents, press the button to release the baby belt from the belt buckle, and remove the child from the vehicle seat immediately.

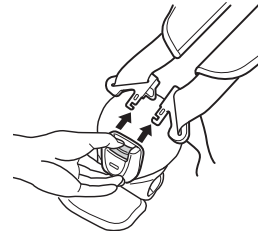

Before use

For safe use of the child car seat

WARNING

Before use

The following misuses may cause malfunction to the child car seat and lead to danger.

- Always keeps the baby belt fitting tight. Any looseness may get caught around the child's neck and may become the cause of suffocation. Please adjust the baby belt to suitable length. (Please refer to P.13-15)



- Contact local distributor in case the belt buckle is jammed with dust or food crumbs and does not function well.



- Please store the adjustment belt in the adjustment belt slot or the belt may strangle and suffocate the child.

- Do not use the baby belt if any damage is found. Please contact local distributor and retailer for any enquiries.



- Always use the inner cushion in backward facing position for child under 7kg. (Please refer to P.12)



- The buckle button may be pressed and released accidentally by the child. It is important periodically to check the baby belt is well fastened.



- Structural damage may happen to the product when it is knocked or made to fall from high level. In such case stop using it even if the knock is one-off and no physical damage.



- Do not carry the child car seat when the child seating in.



- Do not install on a vehicle seat of where the seat belt is damaged.



- Make sure the baby belt is loosened when adjusting the headrest. Adjusting the headrest may tighten or loosen the baby belt. When the baby belt is fastened, do not adjust the headrest.



For safe use of the child car seat

⚠ WARNING

The following misuses may cause malfunction to the child car seat and endanger the child or other passengers.

- Always fix the child car seat securely with the vehicle seat belt although the child is not seated.



- Do not install on the front seat of 2-door or 3-door vehicle in case it may obstruct passengers from getting out the vehicle in emergency.



- Please install on the rear vehicle seats, in case of the child car seat may obstruct the driver view to the side mirror.

- Do not install the child car seat in the passenger seat if installation inhibits proper safe use of the gearshift or handbrake.

- Do not leave the child in the vehicle unattended. In hot days the cabin temperature may rise and endanger the child to heat stroke or dehydration, it may also become the cause of accident. An adult should accompany all the time.



⚠ DAILY CHECKING

For full function of the child car seat, please check the following items before use.

Check if the baby belt is not loose and not twisted.

Check if the insert metal has been fastened into the buckle, and the indicator turns green.

The length of baby belt should be well fitted properly. (by using the adjustment belt)

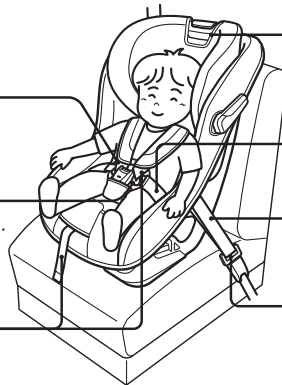

The headrest together with the baby belt has been adjusted to the correct position.

Always pull down the waist belt to hold the pelvis position.

Check if the vehicle seat belt inside the car is not loose and not twisted.

The insert metal of the seat belt is totally fastened into the buckle.

The figure shown in an example of forward facing mode.

Before use

For safe use of the child car seat

! CAUTION

Before use

- Exposing the child car seat to direct sunlight will cause the insert metal or other parts of the child car seat to get excessively hot. Always touch and check all parts before seating the child. Failure to do so may cause burns. Please park the car into the shade area or cover up the child car seat while in the sunny day or summer time.



- Seat cushion must be attached when using. Do not replace any parts of child car seat by other things (which may affect proper functions).



- Do not modify the child car seat or handle it in the ways not stated in this user guide.



- Do not put a piece of cushion etc. on or in between the vehicle seat and the child car seat.



- Do not apply unauthorized parts or parts not included in sales package. Improper usage of parts may damage the product or cause accidents.

- Due to the surface material of vehicle seat, scratch mark may remain after installation.

- Do not use child car seat as a normal chair, it may tip over or fall off. Never use the child car seat for a purpose other than the application mentioned in the user guide. This child car seat is designed to use in the car only.



- Do not expose the child car seat to windy or rainy environment.

- Make sure the child car seat is not jammed in between the vehicle doors or other movable parts.



- Do not leave things unsecured in the vehicle. Things may fall off onto the child when the vehicle is in motion.



- Do not adjust or operate the child car seat while driving. Make sure while driving that the child do not play with the child car seat.



- Parents with long nails or gel nails should pay attention when operating the child car seat in case nails are jammed in movable such as the buckle.



Using the inner cushion



Inner cushion is designed to offer extra protection to newborns, and is only applicable to backward facing mode (cushion is attached to the child car seat in sales package.) Using method varies according to baby's body weight.

⚠ DANGER
 • Wrong usage of inner cushion may endanger baby. Please use correctly.

⚠ WARNING
 • Do not apply the inner cushion in forward facing mode.
 • Both head pad and seat pad must be used for baby below 7kg.
 • Either forward facing or backward facing mode can be used for child who weighs over 9kg and under 10kg. Regardless of the weight conditions, do not use the inner cushion while using forward facing mode.

⚠ CAUTION
 • Do not place detached inner cushion inside the vehicle, in case it may move around when sudden brake and affect driving.
 • Do not carry the child car seat with the inner cushion.

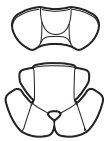
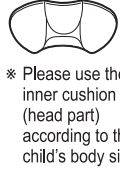
3 different usages according to the baby weight.

| Backward facing | | Forward facing |
|---|--|---|
| <p>2.5kg Weight</p> <p>1 Weighing below 7kg Both inner cushion (head part) and inner cushion(seat part) should be used.</p>  | <p>9kg 10kg</p> <p>2 Weighing between 7 -10kg Do not use the inner cushion(seat part). * Please use the inner cushion (head part) according to the child's body size.</p>  | <p>25kg</p> <p>3 Weighing between 9-25kg Do not use the inner cushion</p>  |
| <p>Please also adjust the shoulder belt after changing the using method of the inner cushion.</p> | | |

Attaching the inner cushion (head part)

- 1 Release baby belt. (Refer to P.14 for operation of baby belt.)
- 2 Lift headrest to the utmost position. (Refer to P.13 for operation of headrest.)
- 3 Route the attachment string through the insert outlets in the middle of the headrest cover.
- 4 Flip over the headrest cover and route the attachment string through the left and right shoulder belt insert outlets.
- 5 Tighten up the attachment string at the back of the main body.

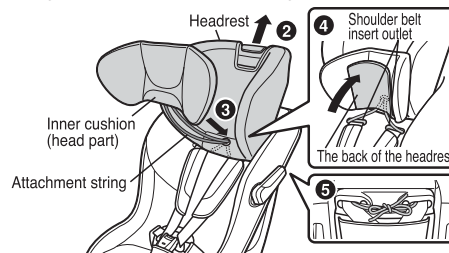

Removing inner cushion (head part)

Follow the steps 1 → 2 → 5 → 4 → 3 to remove the inner cushion (head part) from car seat.

Attaching the inner cushion (seat part)

- 1 Press on the belt buckle and release the insert metal (refer to P.15). Place inner cushion (seat part) onto the seat base.

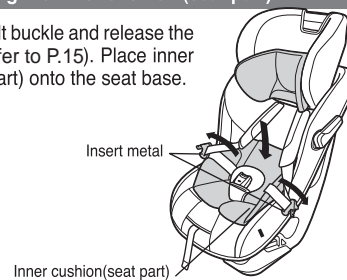

Before installing to the car

Length adjustment of the baby belt

Adjusting the position of the headrest will also change the position of the shoulder belt. Please adjust the headrest according to the shoulder belt position reference below. Shoulder belt insert outlets vary according to forward and backward facing. (please refer to P.13 regarding the adjustment of the headrest)

⚠ WARNING

- Please adjust the position of the shoulder belt according to forward or backward facing mode.
- Do not seat child into the car seat when it is in an unstable situation to avoid child from falling off. Pay particular attention when checking out installation inside your house.

The position of the shoulder belt

• Backward facing

Use the pair of insert outlets just below (around 3cm) the baby's shoulder position.

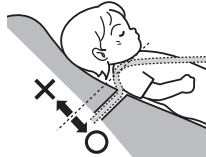

• Forward facing

Use the pair of insert outlets just above (around 3cm) the baby's shoulder position.



The height of the headrest can be adjusted (13 pitches).

- 1 Loosen the baby belt (please refer to P.14).
- 2 Pull the headrest adjustment lever to adjust the headrest.

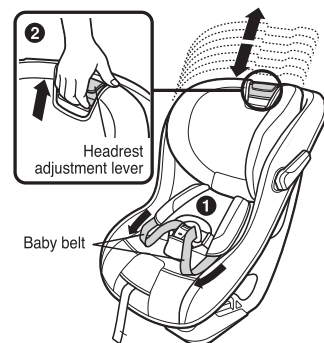

- 2
 - 1 Release the headrest adjustment lever at the desired position. Adjustment lever will click in place.
 - 2 Make sure the adjustment lever secures into place.
 - * Adjustment lever is not secured yet if indicator shows red color.
 - 3 Move the headrest slightly up and down to confirm if it is secured.

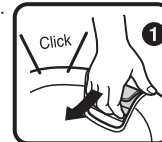

⚠ WARNING

- It is dangerous to use the child car seat when the indicator shows red and headrest adjustment lever is not secured.

Seating the child

⚠ WARNING

- Do not let baby wear clothes from which legs cannot be separated.
- Do not wrap the baby with towels and etc.
- Do not let baby wear too many clothes.
- Do not seat baby in wrong position as illustration. Otherwise baby may be endangered.



- 1 Flip over the adjustment belt slot and press on the PUSH button inside.
- 2 Get hold of the left and right baby belt and pull them towards yourself to loosen them.
* Pull the shoulder belt cover cannot release the baby belt. Please pull the baby belt.

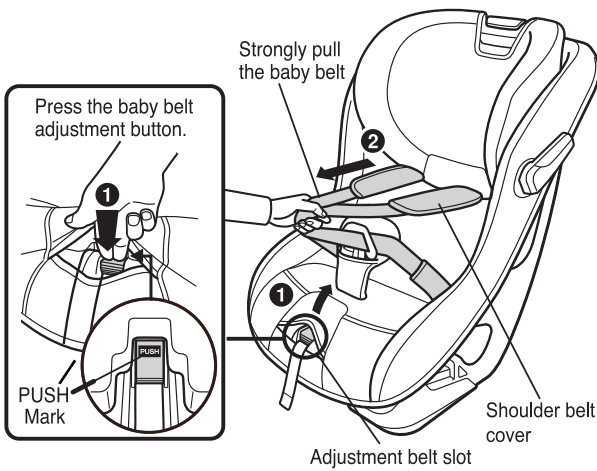

- 2 1 Press onto the buckle button and release insert metal.
- 2 Seat child into the child car seat and place the baby belt over the child's arms.
- 3 Check and make sure the baby belts are not twisted.

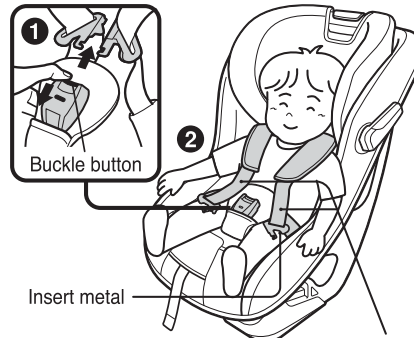

- 3 Make sure the left and right baby belt are not twisted



Before installing
to the car

Seating the child

Before installing to the car

- 3** Match both insert metals together and fasten it into the buckle until a "click" sound is heard.

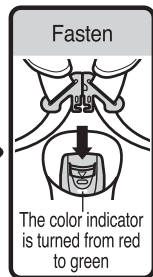
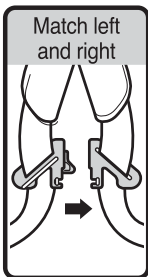

! WARNING

- Always make sure buckle is secured. Otherwise, baby may tumble out in collision. Loose belt may suffocate child.

HINT • The buckle button is designed to be hard to press for baby, for safety reason.

- 4** To shorten the baby belt.

- 1 Always pull down the waist belt to hold the pelvis position.
- 2 The shoulder belt should be located in the center of the child's shoulder.
- 3 Get hold of the adjustment belt and pull it toward yourself until there is a gap sizing around an adult's palm in between the baby belt and the child's body.



- 3** Make sure there's a palm's space between the body and seat belt.



HINT • Adjust the baby belt to an appropriate length.
• Refer to "Seating the child" step 1 (P.14) when loosening the baby belt.

! WARNING

- Always adjust the baby belt to fit the baby's body. Otherwise, baby may tumble out in collision.
- Loose belt may strangle baby's neck and cause suffocation.

When the crotch belt is too tight

Remove the seat base cover from the seat base when the crotch belt cover is becoming too tight.

- 1 Release the 2 hooks and remove the seat base cover.
- 2 Hold on the seat base cover and urethane pad and remove them from the seat base through the insertion outlet.

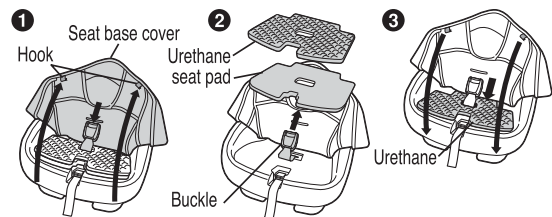

- 3 Route the belt buckle through the urethane and place it back onto the seat base.
- 4 Restore the seat base cover.

Installing to the car

This section describes the caution during installation, and the installation methods of backward facing mode and forward facing mode. Our child car seat may not be able to install on particular seat with extra-ordinary seat shape. Please refer to P.7.

DANGER

- Unsecured child car seat may not function as designed and may cause to danger. In such case, try to install to other seats.
- Always fix the child car seat with vehicle seat belt during installation.
- Do not install the child car seat onto the vehicle seat equipped with an air bag. In case of collision, the exploded air bag will expose the child to major impact which is extremely dangerous.

*Only install the child car seat to vehicle seat with a side air bag is acceptable.

WARNING

- Do not install on a vehicle seat of where the seat belt is damaged.
- Install the child car seat to rear vehicle seats, in case of the child car seat may disturb the driver view through the side mirror.
- Always secure the child car seat with seat belt inside the vehicle although the child is not seated.
- Do not install the child car seat in the front passenger seat if installation inhibits proper and safe use of the gearshift or handbrake.
- Do not install on the front seat of a 2-door or 3-door vehicle in case it may obstruct passengers from getting out the vehicle in emergency.

Preparation

Before installation

- 1** Park the vehicle on flat ground where both left and right door can be opened completely.

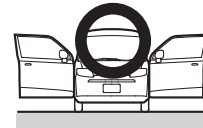

- 2** Slide the front seat forward and recline the backrest to the front for easier installation.

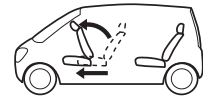

To install on vehicle seats with sliding function

- Slide the seat forward after installation and the child car seat will become even more secured.



Installing to the car

Backward facing installation (for baby weighs under 10kg)

In backward facing installation, open the installation angle adjuster and use the vehicle seat belt to secure the child car seat.

- 1** ① Open the installation angle adjuster entirely.
② Place the child car seat onto the vehicle seat, facing the rear side.

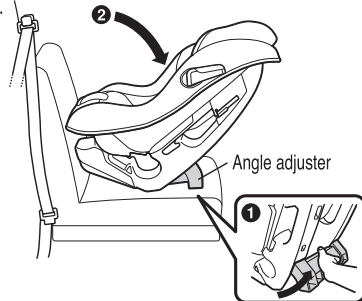

- 2** ① Pull out the seat belt slowly and make sure it is not twisted.
② Route it through the seat belt guide
③ Pull the seat belt from the seat belt guide on the opposite side of the buckle and fasten the insert metal into the buckle until click sound.

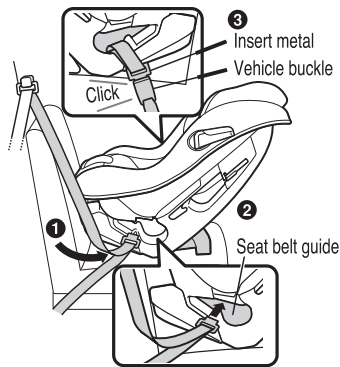

- 3** ① Route the vehicle seat belt (waist belt) through the blue colored lower backward facing vehicle seat belt guide for backward facing installation. (refer to P.4 for the location of the blue mark).
② Route the vehicle seat belt(shoulder belt) through the blue colored lower backward facing vehicle seat belt guide on the same side where the vehicle belt buckle is located.

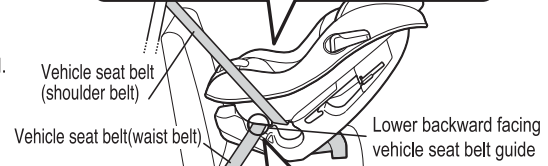
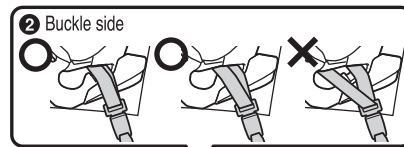

- 4** Press onto the main body of the child car seat and tighten vehicle seat belt(shoulder belt) so as to remove any looseness on the vehicle seat belt(waist belt).

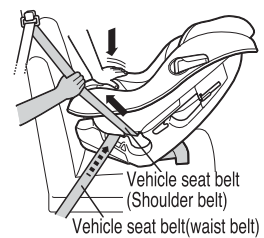

Backward facing installation (for baby weighs under 10kg)

- 5** Pull the shoulder belt and then place the shoulder belt through the shoulder belt guide (upper) located at the opposite side of the vehicle seat belt buckle.

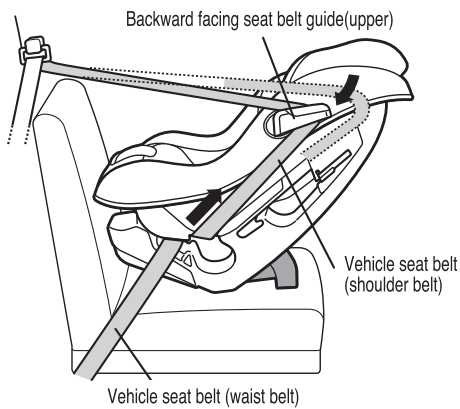

- HINT**
- Make sure only the shoulder belt guide (upper) at the opposite side of the vehicle seat belt buckle is used in the installation.
 - Certain types of vehicle seat belt with car seat securing function may lock automatically when being completely pulled out, prohibiting proper installation.
 - * Pay attention not to pull out too much of the vehicle seat belt.
 - Refer to P.17 step 1 to go over the installation again when the vehicle seat belt locks into place.

! WARNING

The backward facing seat belt guide(lower) touches the buckle.

Belt buckle

- Do not use the child car seat when it becomes unstably installed since the backward facing seat belt guide(lower) touches the buckle, the belt buckle is loose

Lower backward facing vehicle seat belt guide

- If the extension point of the vehicle seat belt is located in front of the backward facing seat belt guide(lower) installation may become unstable.

Please contact local distributor for any inquiries.

Backward facing installation (for baby weighs under 10kg)

- 6** Adjust the car seat installation angle. Make sure the bottom of main body and the installation angle adjuster are tight against the vehicle seat base, and that the front end of child car seat is tight against the backrest of vehicle seat.

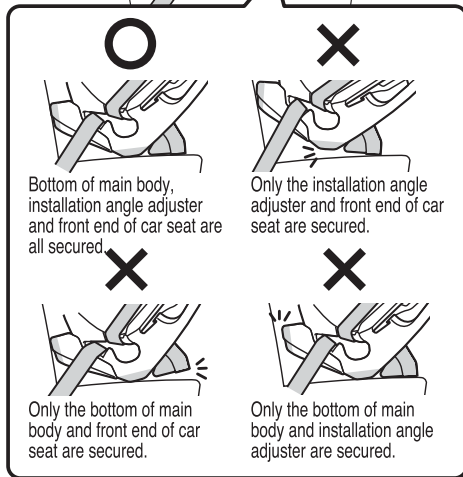
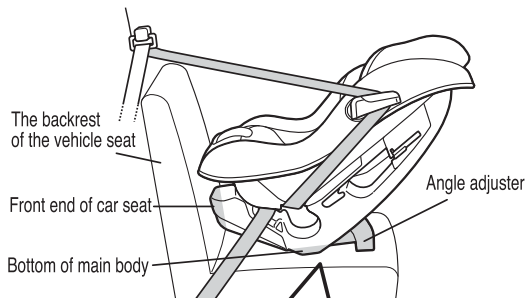

HINT • Backward facing installation reference.

- 1** Place the back cover of the user guide (this book) along the reference line at the side of the main body as illustrated.

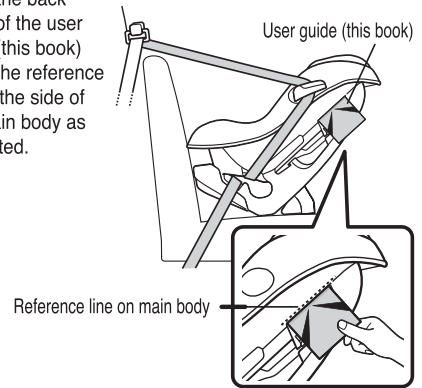

- 2** Make sure the vertical line (90 degree from the horizontal surface) lies within the orange area in the angle checker.

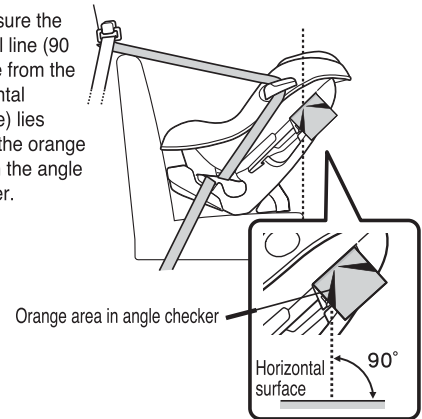

Check-list after backward facing mode installation

Check the followings after the installation.

- ① Check if the angle adjuster has been entirely pulled out.
- ② Check if the vehicle seat belt is fastened.
- ③ Check if baby weighing less than 7kg is using both inner cushion. (head part) and (seat part)
- ④ Check if the waist belt is secured into the backward facing waist belt guides (x2 places).
- ⑤ Check if shoulder belt is secured into the backward facing shoulder belt guide(lower) on the buckle side.
- ⑥ Check if shoulder belt is secured into the backward facing shoulder belt guide(upper) on the opposite side of the buckle.
- ⑦ Check if the seat belt is too loose or is not twisted.
- ⑧ Make sure the bottom of main body and the installation angle adjuster are tight against the vehicle seat base, and that the front end of car seat is tight against the backrest of vehicle seat.
- ⑨ Move the car seat slightly back and forth to make sure it is secured from the backrest of vehicle seat.

※ Car seat may slightly move to the left and right and it is considered normal.

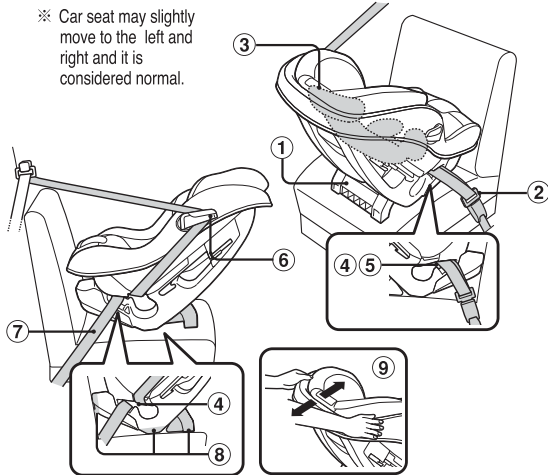

Forward facing installation

(for child weighs from 9kg - 25kg)

In forward facing installation, store the angle adjuster and use the vehicle seat belt to secure the child car seat.

- 1 ① Store the angle adjuster back to the main body until it clicks into place.
- ② Place the child car seat onto the vehicle seat, facing the front side.

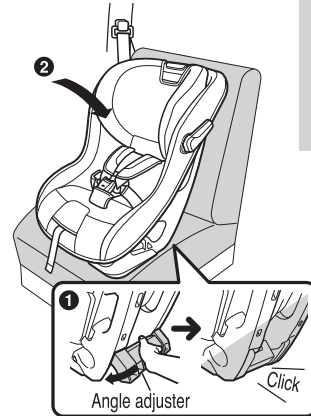

Installing to the car

- 2 ① Pull out the vehicle seat belt slowly (make sure it is not twisted)
- ② Pull it through the seat belt guide.
- ③ Pull out the seat belt from the other side of the seat belt guide. Fasten the insert metal into the buckle until click sounds.

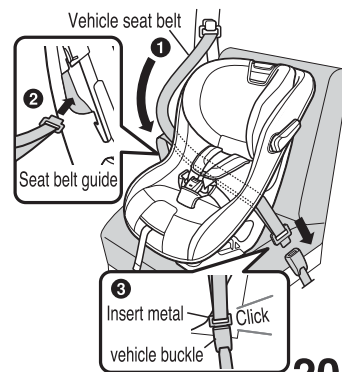

20

Forward facing installation (for child weighs from 9kg - 25kg)

- 4 Pull the waist belt through the left and right red mark of forward facing seat belt guide (lower).
- 5 Pull the shoulder belt through the red mark of forward facing seat belt guide (lower) on the buckle side.(please refer to P.4 regarding the location of the red mark).

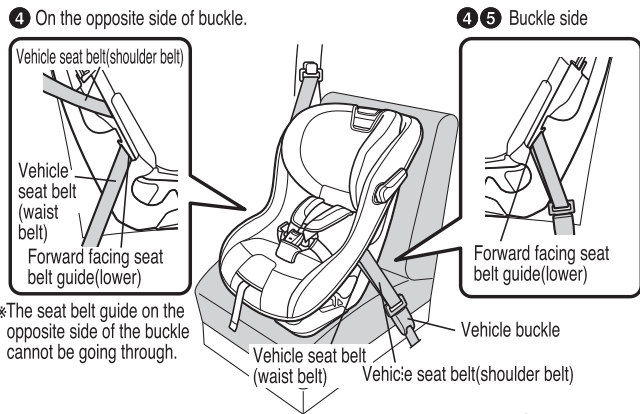

- 3 1 Kneel on the centre of the child car seat and add on body weight to secure the child car seat onto the vehicle seat.
- 2 Tighten the vehicle shoulder belt to the indicated direction (parallel to the horizontal surface) to remove looseness on the waist belt.
- 3 Keep the shoulder belt in tightened position and then open the locking device on the opposite side of the buckle.
- 4 Clip the shoulder belt into the locking device and press it down to close.

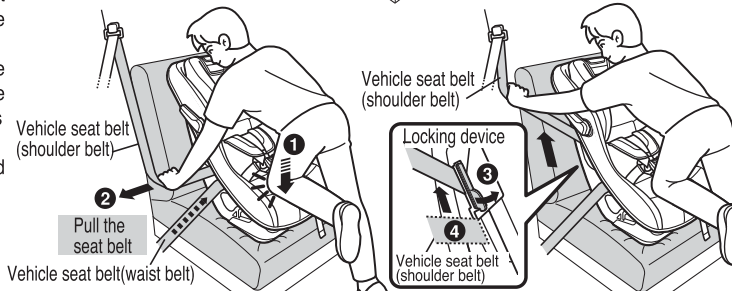

! WARNING

The car seat may become unstable if the vehicle seat belt buckle is touching at the belt guide (lower) for forward facing installation. Do not use the car seat in such circumstance.



Installation may become unstable on a vehicle seat of which the extension point of the vehicle seat belt buckle is located at a point in front of the belt guide (lower) for forward facing installation.



Check-list after forward facing mode installation

Check the followings after the installation.

- ① Check if the angle adjuster is properly stored.
- ② Check if the seat belt is fastened and not twisted.
- ③ The waist belt is pulling through the left and right forward facing seat belt guide(lower).
- ④ The shoulder belt is routing through the forward facing seat belt guide on the buckle side(lower).
- ⑤ The shoulder belt is routing through the forward facing seat belt guide on the opposite of the buckle.
- ⑥ The vehicle seat belt is not too loose or not twisted.
- ⑦ Try to push the child car seat back and forth to make sure dislocation, if any, should not exceed 3cm.

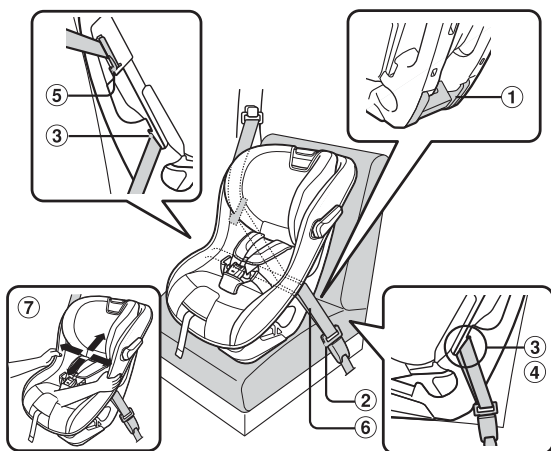

Detaching the seat cover

Please refer to P.12 to understand more about the inner cushion.

Headrest cover

- ① Pull the headrest to the highest position.(please refer to P.13 for this operation).
- ② Release the rubberband inside the headrest cover to take out the headrest cover from the headrest.

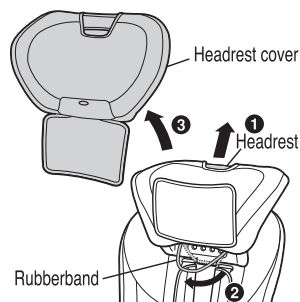

Seat cover

- ① Release the 2 hooks on the inner side of the seat.
- ② Release the 6 hooks on the outer side of the seat cover.
- ③ Detach the seat cover.

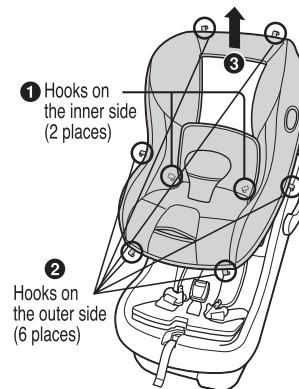

Detaching the seat cover

Shoulder belt cover

- 1 Pull the baby belt until it appears to be protruded out of the baby belt storage cover. (please refer to P.14 for the method.)
- 2 Release the baby belt adjustment metal from the baby belt.
- 3 Pull the baby belt out from the shoulder belt cover.

※ Pull the shoulder belt to detach, not to the shoulder belt cover.

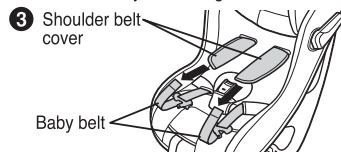
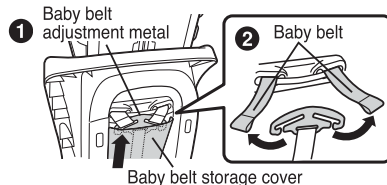

- 4 Press on the shoulder belt insert outlet from the front side of the main body and pull the shoulder belt cover from the back side.

※ Left and right shoulder belt cover are connected by connection belt.

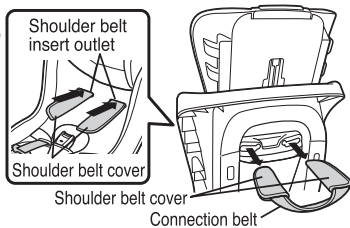

Waist belt cover (EG type only)

Release the snaps as illustrated.

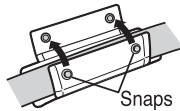

Attaching the seat cover

Shoulder belt cover

- 1 Adjust the headrest to the highest position.
- 2 Open the baby belt storage cover by releasing hooks on both sides.
- 3 Put the shoulder belt cover through the shoulder belt insert outlets and pull them out of the seat front.

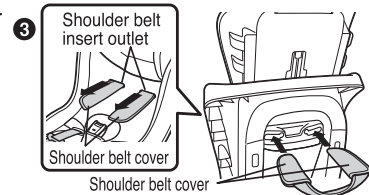
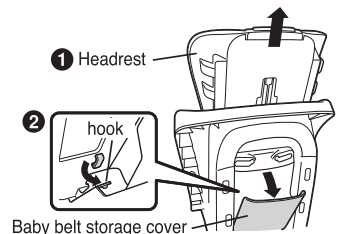

- 4 Pull the baby belt from the shoulder belt cover to the back of the child car seat. Make sure it is not twisted.

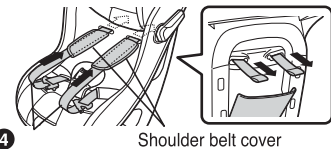

- 5 Attach the baby belt to the baby belt adjustment metal.
- 6 Close the baby belt storage cover and secure the hooks.

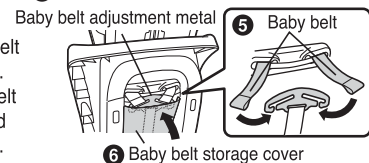

HINT When the baby belt is too short to be secured onto the baby belt adjustment metal, press onto the baby belt adjustment button and pull the baby belt adjustment metal upward.

Attaching the seat cover

Waist belt cover (EG type only)

Secure the snaps as illustrated.

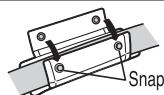

Seat cover

- 1 Place the seat cover onto the main body.
- 2 Fasten the two hooks on the seat.
- 3 Secure the 6 hooks on the outer side of the seat cover.

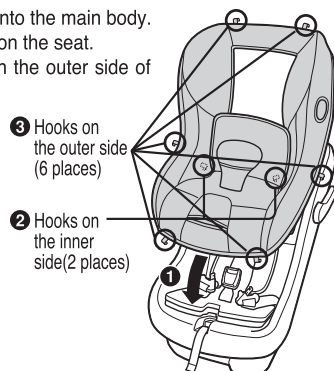

3 Hooks on the outer side (6 places)

2 Hooks on the inner side (2 places)

Headrest cover

- 1 Attach the headrest cover from top to bottom.
- 2 Secure the rubberband inside the headrest cover.
- 3 Adjust the baby belt so that it stays on top of the seat cover and headrest cover.

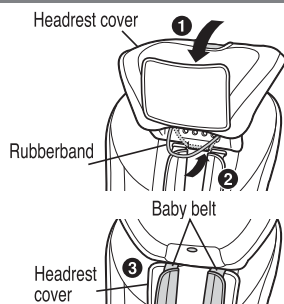

Headrest cover

Rubberband

Baby belt

Headrest cover

Washing method

Washing the seat cover, headrest cover, shoulder belt cover, waist belt cover(EG type only) and inner cushion.

- Please follow the washing instructions below.

| | |
|--|-------------------|
| only use hand wash in water below 30C. | Do not iron. |
| Do not bleach. | Do not dry clean. |
| Light squeezing. | |
| Flat dry at cool place. | |

- * Do not use detergent with fluorescent brightener.
- * Do not use washing machine, dehydrator and drying machine.
- Remove the urethane foam before washing the inner cushion

Information about the urethane

The dyestuff of seat cushion may transfer onto the urethane. However, it is no problem to use.

Maintenance of the main body and baby belt

Simply wipe with a piece of wrung wet cloth, or use diluted neutral detergent for cleaning. After cleaning, cool dry the body in shade.

WARNING

Do not use undiluted detergent, gasoline or other organic solvents when cleaning. Otherwise it may cause damage to the main body or the baby belt.

Storage

Storage

Main body

When the child car seat will not be in use for a period of time, uninstall it and store in shaded place clear from children.

User guide

Please read the user guide carefully and always keep in the user guide storage pocket. (Please refer to P.4)

Product specification

- **Product Size**
(W)510 x(D)620~625x(H)665~825
- **Product weight**
EG : 7.5kg
S : 7.3kg
- **Material**
Main body : Polypropylene / Polystyrene / Urethane
Seat cover : Outer: Polyester
Inner : Urethane