

Combi

Child Car Seat Mamalon

User Guide

- For safety of the baby, please read this user guide carefully before use and use the product accordingly.
- Store this user guide in the pocket underneath the main body.
- Please contact the local distributor if you have any questions about the installation and found any problem about usage.
- Keep this user guide always together with the child car seat.

This product is tested and certified according to ECE R44/04.

- Universal : G0, G1, G2
- Applicable weight : up to 25kg

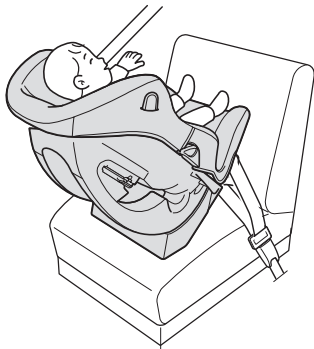

DANGER

Please install the child car seat in backward facing mode for baby weighing below 9kg. It is very dangerous to use forward facing mode under this condition.

CAUTION

No continuous use for a long period, suggests to take a rest in every hour use of considering the child may exhaust. Also, always pay attention to child's physique change until child can control his/her neck of head movement.

1

1a

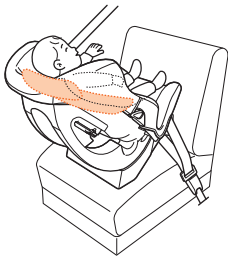

1b



1c



2

2a



2b



2c

less than 40cm

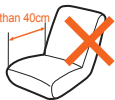

2d



2e



2f



2g



2h



2i



2j



3

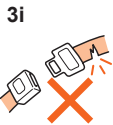
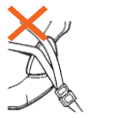
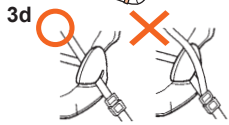
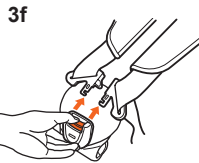
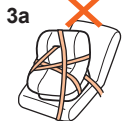

4



5

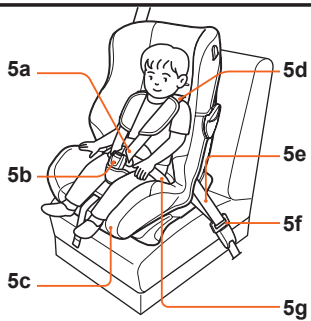

6

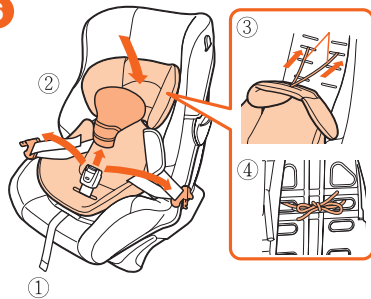

7

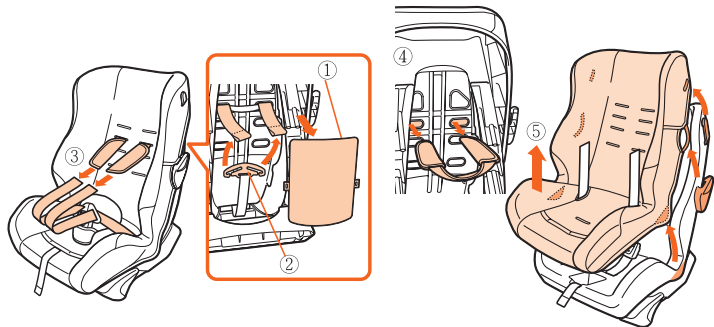

8

10a

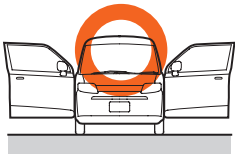

10b

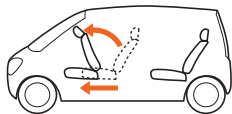

10c

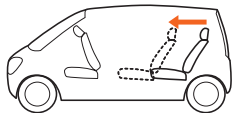

Vehicle headrest

10d

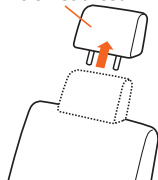

Name of parts

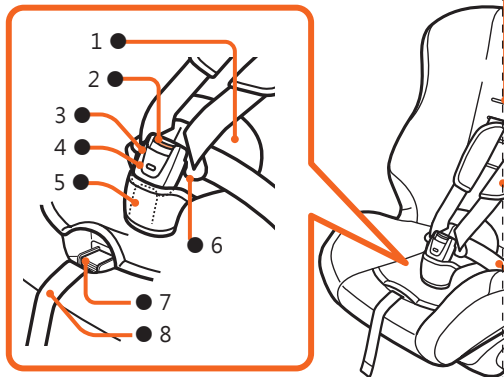

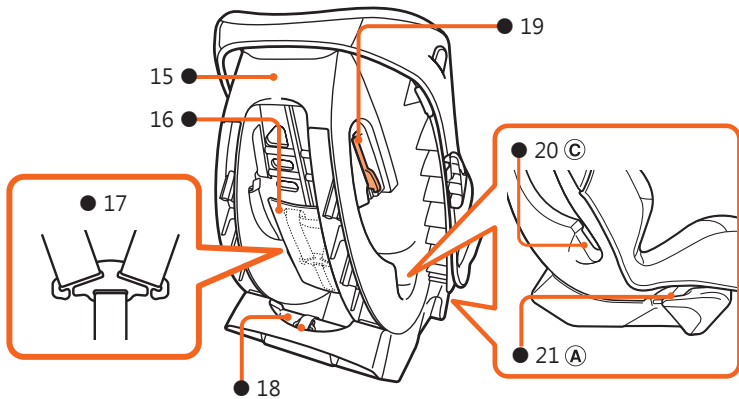
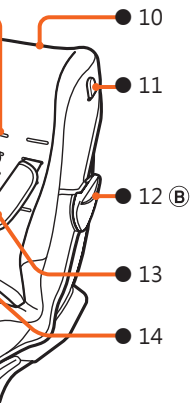

List of components





1. Crotch belt cover
2. Buckle button
3. Buckle
4. Color indicator
5. Crotch belt
6. Insert tongue
7. Adjustment button
8. Adjustment belt
9. Shoulder belt insert outlet
10. Seat cover
11. Guide clip
12. Seat belt guide **(B)**
13. Shoulder belt cover
14. Baby belt
15. Lot No sticker
16. Baby belt storage cover
17. Baby belt adjustment metal
18. Instruction manual slot holder
19. Locking device (red color)
20. Seat belt guide **(C)**
21. Seat belt guide **(A)**

Before use

Thank you for purchasing our child car seat. Before use, please read the user guide carefully and pay utmost care when using the product.

This child car seat does not guarantee protection from injury in all situations, however, using it appropriately can reduce injury and prevent death. Never leave the child unattended: it may be dangerous. Your child's safety is your responsibility.

The caution items mentioned in this user guide are for your reference in order to use this product safely. [danger], [warning] and [caution] indicate the potential consequences if the mentioned are not followed properly and are categorized according to the level of severity.

| Labels | Contents of the labels |
|---|---|
|  DANGER | Improper operation will directly result to death or severe injury. |
|  WARNING | Improper operation may cause death or severe injury. |
|  CAUTION | Improper operation may cause injury or damage to the product. |
|  HINT | It is the recommendations about usage of child car seat and useful hints. |

Instructions and Guidelines

This part describes how to determine the installation direction, explains how to use inner cushion. Use properly according to the baby body weight.

| For Baby weighing under 10kg | For Baby weighs from 9kg - 18kg | Baby weighing from 15kg - 25kg |
|--|--|--|
| Group 0 (Pict 1a) | Group I (Pict 1b) | Group II (Pict 1c) |
| <ul style="list-style-type: none"> • Backward facing against driving direction. • Weight under 7 kg, the inner cushion is required to use. • Make sure to use 5-point seat belt of the child car seat. | <ul style="list-style-type: none"> • Make sure to use 5-point seat belt of the child car seat. • Using the inner cushion is prohibited. • Forward facing against driving direction. | <ul style="list-style-type: none"> • Forward facing against driving direction. • Using the inner cushion is prohibited. • Using the vehicle seat belt, but not using the 5-point seat belt of child car seat. |
| <ul style="list-style-type: none"> • Height reference : ~75cm • Age reference : newborn to one year old • Newborns are referred to newly born infants weighing above 2.5kg and carried for above 37 weeks in pregnancy. | <ul style="list-style-type: none"> • Height reference : Around 75~105cm • Age reference : 1~4 years old | <ul style="list-style-type: none"> • Height reference : Around 95~120cm • Age reference : 3~7 years old |

- DANGER :**
- Please note that the applicable height and age stated above are for reference only. Please refer to the weight conditions in order to choose the appropriate mode to use with.
 - Do not use in forward facing position until baby weight is over 9kg.

Types of seat belt and important notes for installation

Child car seat may apply by different types of seat belt, it may vary by different installation methods or cannot be installed. This product is only applicable to a vehicle equipped with 3-point seat belt requirement of GB14166 or ECE R16 approved. Make sure the fixing points of vehicle seat belts comply with GB requirement.

DANGER

- Please install on the vehicle seat with 3-point seat belt.
- Please do not use the seat with 2-point seat belt.
- Please ensure that the vehicle type is appropriate to use and it works well with this child car seat according to the vehicle user's manual.

| Types of Seat belt | Characteristics (distinction method) | Caution of backward facing mode | Caution of forward facing mode |
|--------------------|---|---|--|
| ELR | Extendable normally but locked in sudden retraction | Slowly pull out the seat belt and fix the child car seat properly. | Slowly pull out the seat belt and using locking device to fix the child car seat |
| AELR | After the seat belt is pulled out completely, it will lock the belt during winding back. Seat belt cannot be elongated anymore. (It will be unlocked after it is completely winded back.) | It is dangerous to completely pull out the seat belt. Please wind back the seat belt and unlock the car seat lock function for installing the car seat. | Using locking device to fix the belt for installation first. After finish the installation, then pull out all the seat belt and then release it. |

WARNING

This product must not be modified in any ways. Do not use the child car seat when it is not equipped with the instructions manual, or any components are missing.

Inapplicable vehicle seats

Do not install this child car seat in case of the following conditions.

- Please do not install this product on unsuitable vehicle seat even though it has not been mentioned below.
- Vehicle seat without seat belt. (Figure 2a)
- Vehicle seat with 2-point seat belt. (Figure 2b)
- Vehicle seat depth less than 40cm. (Figure 2c)
- Bucket type vehicle seat with hollow seat surface. (Figure 2d)
- Vehicle seat facing sideway or backward side against the driving direction. (Figure 2e)
- Vehicle seat with extra large headrest.

Due to the shape of headrest, the headrest adjustment of the child car seat cannot be operated. (Figure 2f)

- ※ On vehicle seat of which the headrest is removable, the child car seat can be used if the car seat is installable after removing the vehicle seat headrest.
- The vehicle seat is equipped with automatic seat belt device.

Automatic seat belt is an automatic device of fastening seat belt after sitting in vehicle seat and vehicle door be closed.

- Vehicle seat equipped with an air bag. (Figure 2g, Figure 2h)
- ※ Vehicle seat with only side air bag is acceptable.
- Vehicle seat with seat belt extending from the center part. (Figure 2i)
- ※ Seat belt is extending from the middle of the vehicle seat where is located in the front of seat belt guide.
- Vehicle seat with a mounted middle portion which cannot secure the child car seat.
- The installation length of seat belt less than 32cm. (Figure 2j)
- ※ The length between the extension point and the buckle of the seat belt.
- Vehicle seat with extremely short seat belt.

Child car seat can be installed:

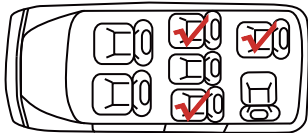

Instructions

DANGER

- Do not seat a child who does not satisfy the applicable conditions, or install the child car seat onto a vehicle seat which is inapplicable.
- Please install correctly according to user guide or indication stickers on the product. (Figure 3a)
- Never use the child car seat as stated in the user guide if it cannot be fixed. Please install the child car seat to the other vehicle seats. (Figure 3b)
- Always fix the child car seat with the seat belt when installing to the vehicle. Never use with a rope, string or other than seat belt to fix it. (Figure 3c) (Figure 3d)
- Do not allow child to stand on the child car seat. Please make sure crotch belt cover and the baby belt are properly installed. The baby belt is well fastened to the buckle and color indicator is shown in green.
- Do not install the child car seat onto the vehicle seat equipped with an air bag. In case of collision, the exploded air bag will expose the child to major impact which is extremely dangerous. Vehicle seat with only side air bag is acceptable. (Figure 3e)

In case of emergency

- In case of emergency, such as accidents, press the button to release the baby belt from the buckle, and remove the child from the vehicle seat immediately. (Figure 3f)

WARNING

- Always keeps the seat belt fitting tight. Any looseness may get caught around the child's neck and may become the cause of suffocation. Please adjust the baby belt to suitable length. (Figure 3g)
- Please store the adjustment belt in the adjustment belt slot or the belt may strangle and suffocate the child.
- Always use the inner cushion in backward facing mode position for child who weigh under 7 kg. (Figure 3h)
- Do not install on a vehicle seat of where the seat belt is damaged. (Figure 3i)
- Do not carry the child car seat when the child seating in.
- Structural damage may happen to the product when it is knocked or made to fall from high level. In such case stop using it even if the knock is one-off and no physical damage. (Figure 3j)
- Contact local distributor in case the belt buckle is jammed with dust or food crumbs and does not function well. (Figure 3k)
- Do not use the baby belt if any damage is found. Please contact local distributor and retailer for any enquires. (Figure 3l)
- Never use this child car seat fitted into vehicle seats facing sideways of facing rearwards. Please install the child car seat on the rear seat since it may obstruct the driver's view to the side mirror.

Instructions

- The buckle button may be pressed and released accidentally by the child. It is important periodically to check the baby belt is well fastened. (Figure 3m)
- Always fix the child car seat securely with the vehicle seat belt although the child is not seated. (Figure 3n)
- Always use the shoulder belt guide if using a junior car seat mode and a booster car seat mode. In case of accident the loosen seat belt from shoulder is very dangerous.
- 5-point seat belt device is designed for a smaller size child to use. If child's physique is applicable to junior seat mode, do not use the 5-point seat belt on the seat.
- Do not install on the front seat of a 2-door or 3-door vehicle in case it may obstruct passengers from getting out the vehicle in emergency.
- Do not leave the child in the vehicle unattended. In hot days the cabin temperature may rise and endanger the child to heat stroke or dehydration, it may also become the cause of accident. (Figure 3o)
- To cover up the child's shoulder by adjusting the shoulder belt guide.

The stress points indication :

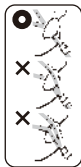
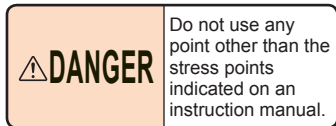

CAUTION

- Prolonged exposure of the child car seat to direct sunlight may cause the insert tongue or other parts of the child car seat to get excessive heat. Always touch and check all parts before seating the child. Failure to do so may cause burns. Please park the car into the shade area or cover up the child car seat while in the sunny day or summer time.
- Do not adjust or operate the child car seat while driving. Make sure while driving that the child do not play with the child car seat.
- Do not use the child car seat as a normal chair, it may tip over or fall off. Never use the child car seat for a purpose other than the application mentioned in the user guide. This child car seat is designed to use in the car only. (Figure 4a)
- Make sure the child car seat is not jammed in between the vehicle doors or other movable parts. (Figure 4b)
- Pay particular attention when fastening or adjusting the harness in case you have long finger nails or have applied artificial nails. Nails may accidentally get jammed inside the gaps when operating the child car seat. (Figure 4c)
- Depending on the shape and materials of the vehicle seat, the child car seat may cause wrinkle or scratch onto the vehicle seat.
- Avoid the child car seat exposing to direct sunlight, upper leather may get excessive heat to cause child burn.
- Do not modify the child car seat or handle it in the ways not stated in this user guide. (Figure 4d)
- Do not apply unauthorized parts or parts not included in sales package. Improper usage of parts may damage the product or cause accidents.
- Do not put a piece of cushion etc. on or in between the vehicle seat and the child car seat. (Figure 4e)
- Do not expose the child car seat to windy or rainy environment.
- Seat cover must be attached when using. Do not replace any parts of child car seat by other things (which may affect proper functions). (Figure 4f)
- Do not leave things unsecured in the vehicle. Things may fall off onto the child when the vehicle is in motion. (Figure 4g)
- Do not use the child car seat without seat cover, seat cover is a structure part as an overall performance for child car seat safety restraint. Make sure to use it along and do not replace by other item.

Daily checking

Using the child car seat properly can reduce injury and prevent death, please check the following parts before use. (Figure 5)

- The length of baby belt should be well adjusted. (Figure 5a)
(To adjust by using adjustment belt)
- Check if the insert tongue has been fastened into the buckle, and the indicator turns green. (Figure 5b)
- Check the child safety seat is secured in the vehicle seat. (Grip the side and the base of child car seat to confirm by back and forth shaking.)

(Figure 5c)

- Through the shoulder belt insert outlet to set the shoulder belt holding to the pelvis position. (Figure 5d)
- Check if the vehicle seat belt inside the car is too loose or not twisted. (Figure 5e)
- The insert tongue of the seat belt is totally fastened into the buckle. (Figure 5f)
- Check if the baby belt is not loose or not twisted. Always pull down the waist belt to hold the pelvis position. (Figure 5g)

Using the inner cushion

Figure 6 - Install the inner cushion

Inner cushion is designed to offer extra protection to newborn.

Use the inner cushion if the child's weight is below 7kg.

1. Press the buckle button and release the insert metal, remove the hip part of inner cushion.
2. Remove the crotch belt cover through the crotch belt hole and then install.
3. Installation string pass through the second shoulder belt insert holes from the top to install.

4. At back of the main body to do the installation or the detachment.

DANGER : Wrong usage of inner cushion may endanger baby. Please use correctly.

WARNING : Improper operation may cause to child injury. Inner cushion must be used for baby below 7kg.

Do not apply the inner cushion in forward facing mode for baby above 7kg.

Attach and detach the seat cover

CAUTION : Do not place detached inner cushion inside the vehicle, in case it may move around when sudden brake and affect driving. Do not hold the child car seat with the inner cushion.

Figure 7 - Detach the seat cover

1. Release the storage belt cover at the back of main body.
 2. Release the baby seat belt from baby belt adjustment metal.
 3. Pull out the baby shoulder belt from the baby shoulder belt cover.
- ※ Left and right baby shoulder belt covers are linked.
4. Pull out both baby shoulder belt covers from the back. Pulling out the baby shoulder belt by one side first.
 5. After left and right holes released from the top, then release the side strings and hooks.

Installing to the vehicle:

DANGER : Unsecured child car seat may not function as designed and may cause to danger. In such case, try to install to other seats. Always fix the child car seat with seat belt during installation.

Do not install the child car seat onto the vehicle seat equipped with an air bag. In case of collision,

the exploded air bag will expose the child to major impact which is extremely dangerous.

* Only install the child car seat to vehicle seat with a side air bag is acceptable.

DANGER : Do not install on a vehicle seat of where the seat belt is damaged. Always secure a child car seat with seat belt inside the vehicle.

Do not install the child car seat to passenger seat if affect driving and cause to traffic safety hazards.

Figure 8 - Preparation

1. Park the vehicle on flat ground where both left and right door can be opened completely.
 2. Slide the front seat forward and recline the backrest to the front for easier installation.
- To install on vehicle seats with sliding function Slide the seat forward after installation and the child car seat will become even more secured.
 - About the headrest of vehicle seat Check the shape of headrest in vehicle seat, remove the headrest of vehicle seat if it is detachable.

Match this gray line against the child car seat on the side of the reference line

Angle Checker

To confirm the installation angle use when the child car seat be installed in backward facing mode. Using this Angle Checker to check the line is seen vertical (against the ground around 90°) within the orange area.

● Adjust installation angle until this line is seen vertical within the orange area when checking in the right side of the main body.

To confirm the installation angle use, the child car seat be installed in backward facing mode. Using this Angle Checker to check the line is seen vertical (against the ground around 90°) within the orange area.

● Adjust installation angle until this line is seen vertical within the orange area when checking in the left side of the main body.

Right Side
of the main body

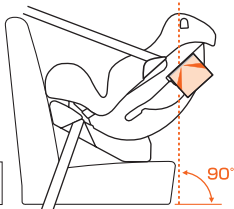

90°

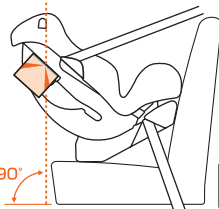

Left Side
of the main body