

Combi

Steam Sterilizer & Dryer 智能雙層消毒烘乾鍋

Instruction manual
使用說明書



Thank you for purchasing this product. Please read this manual carefully before using the product and keep it for future reference. Please also attach this instruction manual in case the product is to be transferred to others to use. 感謝您購買本產品，首次使用產品前請仔細閱讀本使用說明書，請妥善保管本說明書供日後參閱。若將本產品轉讓予他人使用時，請將本說明書也一並移交對方。

Before use 使用前

This product is an indoor household appliance. It can be used to sterilize and dry baby bottles and other items. The steam sterilizer can effectively kill 99.9% of germs. It can hold up 9 bottles. It takes about 51 minutes for sterilization and drying process. The double walled bucket is designed to prevent burns.

本產品是供室內使用的消毒烘乾鍋。可用於消毒、烘乾嬰兒奶瓶及其它適合蒸汽消毒的用品。一次能消毒9支奶瓶，能有效消滅99.9%的細菌。全自動消毒烘乾功能需時約51分鐘完成。奶瓶置放筒採取雙層隔熱防燙設計。

Product specification 產品規格

Voltage 使用電壓	220-240V ~, 50/60Hz
Power consumption 消耗功率	650W (Sterilizer), 175W (dryer) 消毒650W、烘乾175W
Cycle time 工作時間	
Sterilization + Drying 消毒+烘乾時間	About 51 minutes, 6min (sterilization), 45min (drying) 51分鐘左右 (6分鐘消毒+45分鐘烘乾)
Sterilization only 單獨消毒時間	About 6 minutes (Water amount and environmental conditions will affect sterilization cycle time.) 高溫蒸汽消毒6分鐘左右 (依實際水量與氣溫將有所變化)
Drying only 單獨烘乾時間	45 minutes, 10 minutes (2 options) 45分鐘、10分鐘 (2個選擇)
Water amount 加水量	About 70ml 約70ml
Weight 重量	About 3kg 約3.0kg
Product dimension 產品尺寸	L31.6cm×W30cm×H39.5cm 31.6cm (長) x 30cm(寬) x 39.5cm (高)

Packaging contents 包裝內容物

Please check if any part is missing after opening the sales package. Sales package should include the followings.

- Main body
- Tongs
- Instruction manual

使用前請先核對內容物數量是否齊全，包裝箱內含有下列部件。

- 產品本體
- 奶瓶夾
- 說明書



Main body
產品本體



Tongs
奶瓶夾

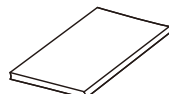

Instruction manual
說明書

Name of components 機體各部名稱

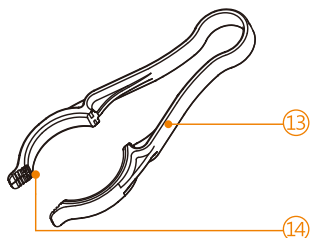
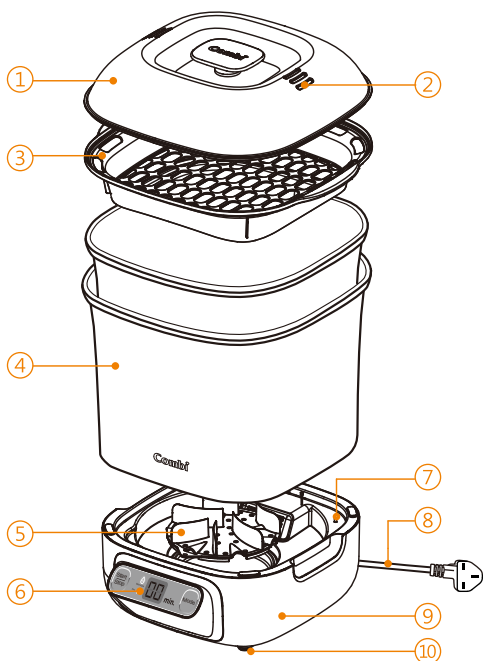

- ① Lid 上蓋
- ② Vent 蒸汽釋出孔
- ③ Basket 置物籃
- ④ Double walled bucket 雙層奶瓶置放筒
- ⑤ Air guide 導風板
- ⑥ Control panel 微電腦自動控制面板
- ⑦ Micro switch 微動開關
- ⑧ Power cord 電源插頭
- ⑨ Base 底座主機
- ⑩ Rubber stand 底腳墊
- ⑪ Filter 過濾網
- ⑫ Stainless steel heater plate 不銹鋼盛水盤
- ⑬ Tongs 奶瓶夾
- ⑭ Tongs liner 奶瓶夾襯墊

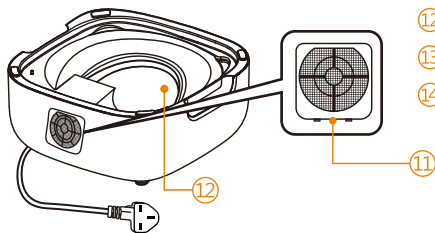

Control panel 面板按鍵功能說明

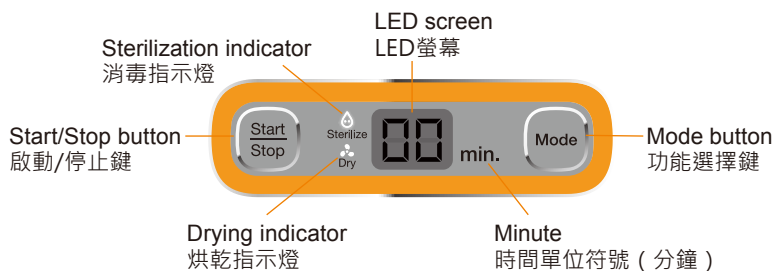

WARNING 警告

1. Do not disassemble the base to avoid the risk of electric shock.
請勿拆卸底座主機，以免發生電擊危險。
2. Do not allow children to use the appliance. Keep the appliance out of the reach of children.
請勿讓兒童使用本產品，請將本產品放到兒童接觸不到的地方。
3. If the power cord is damaged, it must be replaced by the manufacturer or its service agent or a similarly qualified person in order to avoid a hazard.
如果發現電源線損壞，必須交由製造商、製造商授權服務中心，或是具備相同資格的技術人員更換，以免發生危險。
4. The lid of the appliance becomes hot during operation or shortly after operation and may cause burn if it is touched.
消毒、烘乾時或剛消毒、烘乾後，上蓋會非常燙，如果碰到可能會導致燙傷。
5. Hot steam coming out from the vent in the lid or when the lid is opened may cause burn. Do not get close to it.
從上蓋蒸汽釋出孔冒出的蒸汽，或掀開上蓋時冒出的蒸汽可能會導致燙傷，請勿靠近。
6. Do not move the product or open the lid when it is in use.
使用產品時，請勿移動本產品或打開上蓋。
7. Do not move the appliance until it cools down.
移動本產品之前，請務必先待其冷卻。
8. This appliance is not to be used by persons with reduced physical, sensory or mental capabilities or lack of experience and knowledge, unless they have been given supervision or instruction concerning use of the appliance by a person responsible for their safety.
身體官能或心智能力退化者，或是經驗與使用知識缺乏者，可在有人從旁監督或適當指示如何使用本產品，以及瞭解潛在危險的狀況下使用本產品。
9. Do not allow children to play with the appliance.
請勿讓孩童把玩本產品。
10. The stainless steel heater plate becomes hot during operation or shortly after operation and may cause burn if it is touched.
消毒時或剛消毒完，不銹鋼盛水盤會非常燙。如果碰到可能會導致燙傷。

CAUTION 注意

1. This appliance is intended for household use only. Do not use outdoors.
本產品僅供家庭使用，不能在戶外使用。
2. Make sure the voltage indicated on the appliance corresponds to the local mains voltage before connect the appliance.
在連接電源之前，請確保產品所標示的電壓與本地的電源電壓相符。
3. Do not sterilize the bottles and other items which are not suitable for sterilizers. Make sure the items to be sterilized are suitable for steam sterilization.
請確保被消毒物品適合高溫消毒，請勿將本產品用於不能承受高溫的物品。
4. Do not use the appliance if the power cord, plug or the appliance itself is damaged.
如果電源線、插頭或產品本身受損時，請勿使用本產品。
5. Do not use the appliance once fallen or damaged in any way.
如果本產品曾經掉落過或有任何損壞，請勿使用。
6. If there is any visible damage to the appliance, unplug it immediately and stop use it.
如果發現本產品有明顯損壞，請立即拔下插頭並停止使用。
7. Make sure the appliance is installed correctly, or it may not start.
請確保正確組裝本產品，如果組裝錯誤，本產品可能無法啟動。
8. Do not start sterilization if no water in the stainless steel heater plate. Or it may cause damage to the appliance. Make sure to pour around 70ml water into the stainless steel heater plate before sterilization.
盛水盤內未加水時，嚴禁啟動消毒功能，否則可能會導致產品損壞。消毒前務必在盛水盤內加入70ml的水。
9. Only use water without any additives. Can use distilled water (pure water) or filtered water to avoid scale build up. Do not use mineral water or electrolyzed water. 僅可使用不含任何添加物的清水。為減少水垢產生，也可使用蒸餾水（純水）或過濾水。請勿使用礦泉水及電解水。
10. Do not cover the vent in the lid during sterilization or drying.
使用時切勿遮蔽住上蓋蒸汽釋出孔，以免影響正常功能，導致損壞。
11. Environmental conditions such as temperature and humidity may affect the drying effect. If there is still water residue, dry again by selecting 10 minutes drying only or let it dry naturally.
使用時環境溫度與濕度會影響烘乾效果。烘乾後如仍有水珠殘留，可以選擇10分鐘單獨烘乾模式繼續烘乾，或待其自然晾乾即可。
12. Follow the cleaning instruction to clean the scale on the stainless steel heater plate, or it may cause malfunction and odors.
請按照清洗說明清潔盛水盤上的水垢，當水垢太厚時，可能會導致功能異常和異味。
13. Pour out any remaining water from the stainless steel heater plate after cleaning. Do not let water flow into the air outlet.
清潔盛水盤之後，務必將剩下的水倒掉，請勿將水倒入至出風口。
14. Do not immerse the base, the power cord or plug in water or any other liquid.
請勿將底座主機、電源線或插頭浸入水中或任何液體中。
15. Clean the filter regularly. Remove it from the base and rinse with running water. Put it back when it is dry.
主機後面的進風口過濾網需要定期清洗。先將過濾網拆下，用水清洗後晾乾，之後再裝回去。請勿用水清洗風扇，以免水流入內部，造成損壞。
16. Unplug the appliance after use.
使用完本產品後，請務必將插頭拔掉。
17. Keep the appliance away from heat source and direct sunlight.
請勿將本產品放置在高溫的環境裡以及避免陽光直射。
18. Do not place items on top of the appliance when it is in use.
產品使用時，請勿在產品上方放置物品。
19. Do not start another sterilization circle soon after one sterilization circle is finished, let the appliance cool down first. Or it may not be started.
產品在完成一個消毒周期後，不要馬上又啟動消毒功能。必須先讓其完全冷卻。否則可能無法啟動。

How to assemble 基本組裝

- 1 Place the base on a flat table, do not place other items around the appliance.

請將底座主機置放於室內平坦的桌面，並注意本機周圍不要置放其他物品。

Fig.1
圖一

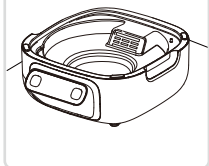

- 2 Put the air guide on the stainless steel heater plate of the base.

請將導風板安裝於底座主機盛水盤上。

CAUTION!

Let the post on the base insert through the hole in the air guide.

注意！
導風板上小孔對位。

Fig.2
圖二

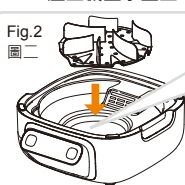

- 3 Assemble double walled bucket letting the arrow on the inner bucket facing the Combi logo on the outer bucket.

請先將雙層奶瓶置放筒內筒放入外筒中。注意內筒上的箭頭和外筒上的Logo為同一方向。

Fig.3
圖三

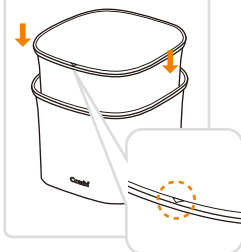

- 4 Put the double walled bucket on the base letting the Combi logo facing control panel.

將雙層奶瓶置放筒安裝於底座主機上。注意雙層奶瓶置放筒的Logo須朝向控制面板。

Fig.4
圖四

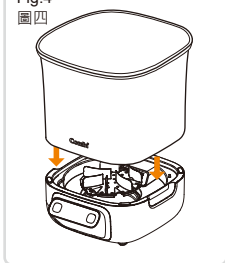

- 5 Attach the basket to the double walled bucket.

請將置物籃安裝於奶瓶置放筒中。

Fig.5
圖五

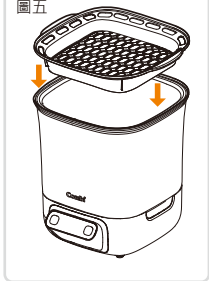

- 6 Cover the lid.

請蓋上上蓋。

Fig.6
圖六

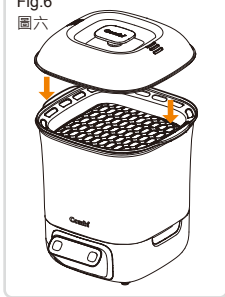

- 7 Connect the plug to the power outlet. The self-detect program will start up and the LED screen will display "--" upon connection. And the appliance beeps simultaneously.

請將本產品的電源插頭，插接於電源插座上，當接上電源時，主機自檢偵測程式，顯示屏會顯示"--"，同時發出"bi"聲，表示已經通電。

How to use 操作說明

Preparation for use 使用前的準備

1. Make sure the items to be sterilized are suitable for sterilizer.
請先確認欲消毒的物品材質，可承受高溫蒸汽消毒環境。
2. Clean the bottles and other items to be sterilized thoroughly.
請先將欲消毒的物品清洗乾淨，確保消毒效果安全。
3. Make sure the appliance is installed correctly, and connect the power cord to the power outlet.
請確認本機基本組裝完整，並已將本機電源線插頭插上電源插座。
4. Remove the double walled bucket, lid and air guide from the base.
請將雙層奶瓶置放筒連同上蓋及導風板自底座主機上取下。
5. Pour around 70ml water on the stainless steel heater plate, it is not necessary to pour any water if selecting drying program only.
請注水入底座主機的不銹鋼盛水盤，注水量約70ml，若只烘乾而不消毒，則不必加水。
6. Put the air guide on the stainless steel heater plate of the base. Let the post on the base insert through the hole in the air guide. (Refer to Fig.2 on left)
請將導風板安裝於底座主機盛水盤上。導風板安裝有對位。(參考左頁圖二)
7. Assemble the double walled bucket to the base. (Refer to Fig.4 on left)
CAUTION: This double walled bucket requires directional assembly, please let the Combi logo on the outer bucket and arrow on the inner bucket facing the direction of the control panel. (Refer to Fig.3 on left)
請將裝配好的內外筒置於底座主機上。(參考左頁的圖四)
注意: 此雙層奶瓶置放筒具有方向性，請將外筒的LOGO和內筒上的箭頭面朝著控制面板的方向。(參考左頁圖三)
8. Place clean bottles with their opening facing downward on the posts as Fig.7 shown. (For dishes, place them in the middle of the posts in the bucket as Fig.8 shown.)
請將已洗淨的奶瓶，瓶口朝下，倒放在奶瓶架上，如圖七。(如需消毒餐盤，請插放在奶瓶架間隔中。(如圖八)
9. Put the basket on the double walled bucket. (Refer to Fig.5 on left)
請將置物籃安裝於雙層奶瓶置放筒中。(參考左頁圖五)
10. Place teats or accessories on the basket as Fig.9 shown.
請將奶嘴或小配件放置於置物籃內。如圖九。
11. Put the lid (Fig.10) on. (Refer to Fig.6 on left)
請蓋上半透明上蓋(圖十)。(參考左頁圖六)

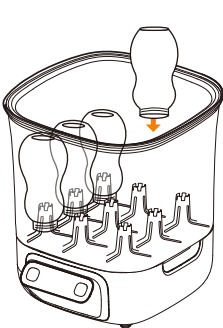

Fig.7

(Bottle height is less than 18cm)
圖七
(奶瓶最高尺寸限定於18CM內)

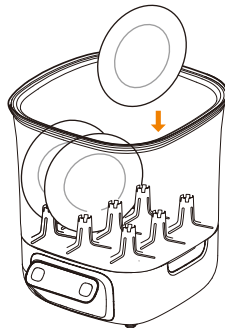

Fig.8

(Dish size is less than 20cm)
圖八
(餐碟最高尺寸限定於20CM內)

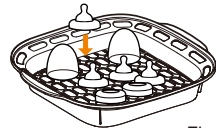
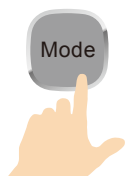

Fig.9
圖九



Fig.10
圖十

Start to use 開始使用



Press Mode button to select desired program
請按下選擇鍵·選擇所需功能



Press Start/Stop button to start desired program
請按下啟動/停止鍵·選擇所需功能



Automatic operation 自動運作

Automatic operation by selected program
依所選擇的功能自動運作



Manually
shut off
手動中斷

Press Start/Stop button to pause.
Press and hold Start/Stop button to shut off
使用中短按“啟動/停止”為暫停
長按“啟動/停止”則強制關機

Detailed operation instruction 細部操作說明

Step 1 步驟 1

Mode

Select desired program (Press Mode button to select the desired program)
選擇功能 (請按下選擇鍵選擇所需功能)

Press Mode button 按下選擇鍵	Display 顯示	Display description 顯示說明
Press once 按1次	 (Initial setting) (Sterilization will not be started until Start/Stop button is pressed) (初始設定) (等待按下啟動/停止鍵·然後才開始消毒)	<ul style="list-style-type: none">● Sterilization + Drying program Pour water on the stainless steel heater plate before sterilization. (Pour around 70ml water) 消毒+烘乾功能 啟動本功能前·請注水入底座主機的盛水盤(注水量約70ml)

Select sterilization + drying
選擇消毒+烘乾功能

Automatic stop when the cycle is finished
運作完成 自動停止

When the appliance stops operation automatically, then it goes into standby mode.







本機運作自動停止後將進入待機關閉狀態

Remove the items
取出物品

When the cycle is completed or shortly after it is completed, the sterilized and dried items may be still hot due to steam and hot air. Use the tongs to take out the items to avoid burn.

因本機採取高溫蒸汽消毒，及熱風烘乾的原理，所以當運作停止後機體與鍋內消毒烘乾物品尚餘高溫，建議在取出鍋內消毒烘乾物品時，請用所附贈之奶瓶夾夾取物件使用，以免燙傷。

Step 2 Start selected program (Press Start/Stop button to start the selected program) 步驟 2 啟動功能 (請按下啟動/停止鍵啟動所選功能)

Press [Start/Stop] button 按下啟動/停止鍵	Display 顯示	Display description 顯示說明
Start sterilization + drying 啟動 消毒+烘乾 功能		<ul style="list-style-type: none"> The sterilization icon (water drop) starts to flash immediately indicating that sterilization is operating after the "Start/Stop" button is pressed. 啟動後，先進行消毒作業，消毒顯示圖示(水滴)開始閃爍，即已開始進行消毒工作
		<ul style="list-style-type: none"> It takes about 6 minutes for sterilization. (It may vary according to water amount and environmental conditions. 70ml is suitable water amount, it is proved by laboratory testing.) 消毒時間約需6分鐘左右(依實際水量與氣溫將有所變化，加水量約70ml，是經過實驗室驗證有效殺毒的水量) LED screen displays "07" indicating that sterilization is operating. 此階段中LED的顯示圖案為消毒鍋正在消毒工作的表示
		<ul style="list-style-type: none"> When sterilization is finished The LED screen and sterilization icon (water drop) flashes for 2 times, then it will switch to drying program. 消毒作業完成時 LED及消毒顯示圖標(水滴)同時閃爍2次後切換至烘乾
		<ul style="list-style-type: none"> When the sterilization cycle is finished, it will automatically switch to the drying program, drying icon (fan) starts to flash indicating that drying is operating. 消毒功能完成後，自動切換到烘乾作業，烘乾功能指示圖標(風扇)開始閃爍，即已開始進行烘乾工作 It takes about 45 minutes for drying. The timer on the LED screen will count down in minute from "45" until it reaches "00". 此階段中LED顯示的數值為烘乾所需的剩餘時間(單位為分鐘)
		<ul style="list-style-type: none"> When drying is finished LED screen "00" starts to flash for 15 times and the appliance beeps for 15 times simultaneously. Then the whole cycle is finished. 烘乾作業完成時 LED中"00"閃爍15次，並同時"bi-bi"響15聲，結束所有工作。
	<ul style="list-style-type: none"> Shut off automatically 自動斷電關機 	

啟動消毒+烘乾功能
Start sterilization + drying





Press Mode button 按下選擇鍵	Display 顯示	Display description 顯示說明
Press once again 再按一次 Select sterilization only 選擇單獨消毒	 (Waiting for start) (為消毒狀態顯示·表示等待消毒)	<ul style="list-style-type: none"> ● Sterilization only Pour water on the stainless steel heater plate before sterilization. (Pour around 70ml water). 單獨消毒功能 啟動本功能前·請注水入底座主機的盛水盤內(注水量約70ml)





Press once again 再按一次 Select 45 minutes drying only 選擇單獨烘乾45分鐘		<ul style="list-style-type: none"> ● 45 minutes drying 單獨烘乾45分鐘功能
---	---	---



Press once again 再按一次 Select 10 minutes drying only 選擇單獨烘乾10分鐘		<ul style="list-style-type: none"> ● 10 minutes drying Environmental conditions such as temperature and humidity may affect the drying effect. If there is still water residue after 45 minutes drying, dry again by selecting 10 minutes drying. 單獨烘乾10分鐘功能 10分鐘烘乾功能建議使用於環境過於潮濕、寒冷、桶內有積水或者物件太多時·正常烘乾不完全情況下·追加烘乾時間使用。
---	---	---

Press [Start/Stop] button 按下啟動/停止鍵	Display 顯示	Display description 顯示說明
Start sterilization program 啟動單獨消毒功能 Start sterilization only 啟動單獨消毒		<ul style="list-style-type: none"> The sterilization icon (water drop) starts to flash immediately indicating that sterilization is operating after the "Start/Stop" button is pressed. 啟動後·將進行消毒作業·消毒指示圖標(水滴)開始閃爍·即已開始進行消毒工作 It takes about 6 minutes for sterilization (It may vary according to water amount and environmental conditions.) 消毒時間約需6分鐘左右(依實際水量與氣溫將有所變化) LED screen displays "07" indicating that sterilization is operating. 此階段中LED的顯示圖案為消毒鍋正在消毒工作的表示
		<ul style="list-style-type: none"> When sterilization is finished LED screen "07" starts to flash for 15 times and the appliance beeps for 15 times simultaneously. Then the cycle is finished. 消毒作業完成時 LED中的消毒狀態顯示圖案"07"閃爍15次·並同時"bi-bi"響15聲·結束所有工作。
		<ul style="list-style-type: none"> Shut off automatically 自動斷電關機

Start 45 minutes drying program 啟動單獨烘乾 45分鐘功能 Start 45 minutes drying only 啟動單獨烘乾45分鐘		<ul style="list-style-type: none"> The drying icon (fan) starts to flash immediately indicating that drying is operating after the "Start/Stop" button is pressed. 啟動後·將進行烘乾作業·烘乾指示圖標(風扇)開始閃爍·即已開始進行烘乾工作 It takes about 45 minutes for drying. 烘乾時間約需45分鐘 The timer on the LED screen will count down in minute from "45" until it reaches "00". 此階段中LED的顯示數值為烘乾所需的剩餘時間(單位為分鐘/min)
		<ul style="list-style-type: none"> When drying is finished LED screen "00" starts to flash for 15 times and the appliance beeps for 15 times simultaneously. Then the cycle is finished. 烘乾作業完成時 LED顯示"00"及烘乾指示燈閃爍15次·並同時"bi-bi"響15聲·結束所有工作
		<ul style="list-style-type: none"> Shut off automatically 自動斷電關機

Start 10 minutes drying program 啟動單獨烘乾 10分鐘功能 Start 10 minutes drying only 啟動單獨烘乾10分鐘		<ul style="list-style-type: none"> The drying icon (fan) starts to flash immediately indicating that drying is operating after the "Start/Stop" button is pressed. 啟動後·將進行烘乾作業·烘乾指示圖標(風扇)開始閃爍·即已開始進行烘乾工作 It takes about 10 minutes for drying. 烘乾時間約需10分鐘 The timer on the LED screen will count down in minute from "10" until it reaches "00". 此階段中LED的顯示數值為烘乾所需的剩餘時間(單位為分鐘/min)
		<ul style="list-style-type: none"> When drying is finished LED screen "00" starts to flash for 15 times and the appliance beeps for 15 times simultaneously. Then the cycle is finished. 烘乾作業完成時 LED顯示"00"及烘乾指示燈閃爍15次·並同時"bi-bi"響15聲·結束所有工作
		<ul style="list-style-type: none"> Shut off automatically 自動斷電關機

Safety device 安全防護裝置

Micro switch (Trigger switch) 微動開關 (觸動開關)

The appliance functions properly only when the micro switch is pressed. The appliance can't start if the double walled bucket is placed on the base in wrong direction cause it can't touch the micro switch. The appliance will alarm for 15 times if the double walled bucket is removed during operation. Then it will shut off automatically.

雙層奶瓶置放筒必須垂直 (LOGO 朝向 LED 面板) 放置於底座主機上。壓到微動開關才能正常運作。若雙層奶瓶置放筒離開底座，或底座不慎傾倒時，則會發出 "bibi-bibi" 警告 15 聲。如於警告聲內未將雙層奶瓶置放筒放置妥當，則會斷電關機。

Switch off when no water for sterilization 無水消毒斷電

When no water in the stainless steel heater plate during sterilization, the appliance can detect this abnormal condition in 40 seconds, LED screen will display Er and the appliance will alarm for 15 times, meanwhile, the fan start to work for 60 seconds, then switch off automatically.

當盛水盤無水時，啟動消毒+烘乾或消毒功能，主機在 40 秒內會自動檢測到異常，LED 顯示 Er 並發出 15 聲 "bibi-bibi" 警告聲，同時風扇開始運行 60 秒後自動斷電，結束工作。

If the selected program is not started within 2 minutes, switch off automatically 2分鐘功能未啟動，自動關閉

If the Start/Stop button is not pressed within 1 minute after pressing mode button, the appliance will return to initial status. And it will switch off automatically after another 1 minute.

按下選擇鍵後，1 分鐘內未啟動則返回到初始狀態，再過 1 分鐘無按鍵操作，則自動關機。

Switch off automatically 結束自動斷電

When the cycle is finished, the appliance will switch off automatically.

選擇功能啟動執行後，當所有程序執行完畢後，本機將自動關機。

Triple circuit protection device 三重電路保護裝置

1. Over voltage protection circuit

PCB equipped with surge protector (varistor) and thermistor. Voltage resistance: 300V AC.

過電壓的保護

電路板上裝有突波保護 (Varistor) & 熱敏電阻，耐壓 300V AC

2. Over current protection circuit

PCB mounted with Fuse.

過電流的保護

電路板上裝有保險絲 (Fuse)

3. Over heat protection circuit

過熱的保護

Sterilization thermostat 蒸氣消毒系統 (溫度開關) : 125°C

Thermal Fuse 溫度保險絲 : 216°C

Drying thermostat 烘乾加熱系統 (溫度開關) : 155°C

Maximum temperature of ceramic PTC heater (230°C) is lower than the heat resistance of the nylon bracket (250°C).

正溫度系數的 PTC 陶瓷防乾燒加熱片，最高溫度 (230°C)，低於尼龍支架耐熱最高溫度 (250°C)

Clean and maintenance 清潔及維護

The lid, basket, double walled bucket and tongs can be cleaned in water directly.

Use a soft damp cloth to clean the base. Do not immerse the base, power cord or plug in water or any other liquid.

Clean the stainless steel heater plate with a damp cloth, wipe off the scale. Deposits can be removed with scale removers or by leaving water and vinegar solution on the stainless steel heater plate for approximately 2 hours.

Clean it repeatedly if there is too much scales building up.

※ Store the appliance in a clean, dry and well ventilated place after cleaning.

上蓋、置物籃、雙層奶瓶置放筒、奶瓶夾等部件：可直接用柔軟的布水洗，再以乾淨的布擦乾即可。

底座主機部分：嚴禁浸入水中清洗，只能以濕布擦拭即可。

底座主機中的盛水盤：以濕潤的百潔布直接擦拭、刷去沉積物。若有附著白色灰質異物時 (俗稱水垢)，可使用食用

白醋加水稀釋 (或水垢清潔劑)，浸泡盤面約 2 小時後再進行清潔；若白色石灰質過厚時，請反覆多清洗幾次即可。

⚠ CAUTION 注意

- Unplug the appliance and let it cool down before cleaning.
清潔前務必先將電源線插頭拔掉並待其冷卻。
- Do not immerse the base, power cord or plug in water or any other liquid.
請勿將底座主機、電源線或插頭浸入水中或任何液體中。
- Clean the stainless steel heater plate regularly to avoid the scales build up, otherwise it may shorten product life or there may be odor.
請定期清潔水盤，以防水垢累積，降低本機壽命，或產生異味有礙衛生。
- Pour out any remaining water from the stainless steel heater plate as illustrated after cleaning. Do not let water flow into the air outlet to avoid damage.
當盛水盤內有水需要傾倒時，請務必注意從倒水的方向，切勿讓水流入出風口內。



Pour direction
倒水方向

Troubleshooting 簡易故障排除

Condition 故障狀況	Possible cause 可能原因	Remedy 排除方法
The appliance will not start. 本機無法啟動	1. Appliance is unplugged. 未通電 2. Wrong voltage. 使用錯誤電壓	Make sure the plug is securely inserted into power outlet. 確插插頭插入電源插座 Make sure the voltage indicated on the appliance corresponds to the local mains voltage. 供電不正常，請使用規定的電壓
"ER" shows on LED screen and warning sound "bibi-bibi" comes up. LED顯示Er，並持續發出"bibi-bibi"聲，無法使用	Double walled bucket is removed from the base during operation. 雙層奶瓶置放桶未正確放置或沒有放置	Put the double walled bucket to the base securely and in correct direction. 將雙層奶瓶置放桶正確放置到位
15times warning sound "BiBi-BiBi" comes up few minutes after sterilization cycle started. 消毒過程中發出15聲"bibi-bibi"警告音。	Misuse that not enough water added in the stainless steel heater plate, sterilization period is less than 3 minutes will cause self-protection program to be initiated. 盛水盤未加足夠水量，消毒時間少於3分鐘，觸發防乾燒保護機制。	Let the appliance cool down, then add about 70ml water to the stainless steel heater plate and restart sterilization. 待盛水盤冷卻後加入70ml水重新消毒。
There is water residue. 殘留水珠	Room temperature is too low, bottle volume is quite large, the material is hard to dry, too much water added. 室溫太低，奶瓶容量大，材質不易乾，加水量較多	Dry again by selecting drying only. 請選擇單獨烘乾功能再次烘乾
There is odor during sterilization. 消毒時產生異味	Stained residue in stainless steel heater plate (milk residue). 盛水盤殘留異物(牛奶殘渣)	Clean the stainless steel heater plate. 清潔盛水盤
There is odor during drying. 烘乾時產生異味	Stained water flows into the air outlet. 不清潔水流入出風口內	1. Never let water flows into the air outlet during cleaning. 使用或清潔時，避免水流入出風口內 2. Store the appliance in a clean, dry and well ventilated place. 請將本機置放乾淨、通風、安全的場所

※ If you cannot remedy the problems by using the above troubleshooting chart. Please unplug the appliance and send to dealer for repair. Do not attempt to disassemble the base.

使用中如有任何不正常情況出現，請先參考以上的簡易故障排除方法，若仍無法正常操作，請拔下電源插頭，送回原購買處或指定服務處維修，切勿自行拆解。

Material and heat resistance 材質與耐溫說明

Part name 部件	Materials 材質	Heat resistance 耐熱溫度
Rubber stand 底腳墊	Thermoplastic elastomers (TPE) 熱塑性彈性體	90°C
Tongs liner 奶瓶夾襯墊	Thermoplastic elastomers (TPE) 熱塑性彈性體	90°C
PTC bracket PTC支架	Nylon (PA) 尼龍	250°C
Other plastic parts 其它部件	Polypropylene (PP) 聚丙烯	114°C

Combi Corporation

2016.10.27